

DIO7929B

5.5V rated 2A capable slew rate controlled load switch

Features

- 1.8V to 5.5V operation voltage range
- Low quiescent current <math><1\mu A</math> when disabled
- Reverse current blocking when switch is off
- Built-in 100 Ω (typ) output discharge resistor
- 45m Ω (typ) N-MOSFET
- DC Current Up to 2A (max.)
- Peak Current Up to 5A (max.)
- Built-in Soft-Start 3ms
- Active High with Integrated Bridge
- Pb-Free Device SOT23-6

Applications

- Cell Phone and Digital Camera
- PDA and Notebook
- LCD Monitor
- TV and Set-Top Box

Block Diagram

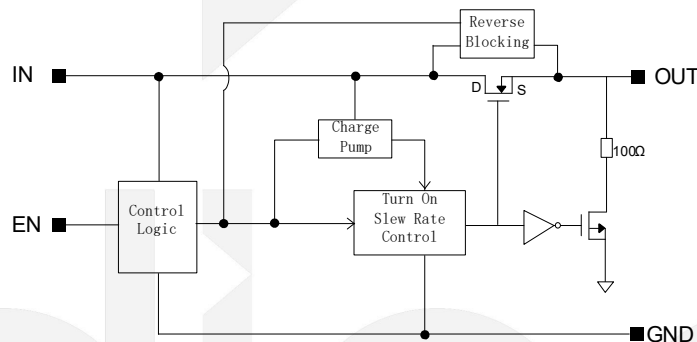

Descriptions

The DIO7929B is a Low On-Resistance N-channel MOSFET controlled by a soft-start sequence of 3ms for mobile applications.

The low $R_{DS(on)}$ allows system supplying or battery charging up to DC 2A. The device is enable automatically if a power supply is connected on V_{IN} pin (active High) and maintained off if no power input (internal pull down).

Due to the current consumption optimization, the leakage current is drastically decreased from the battery connected to the device, which allows extending the battery life.

Typical Application

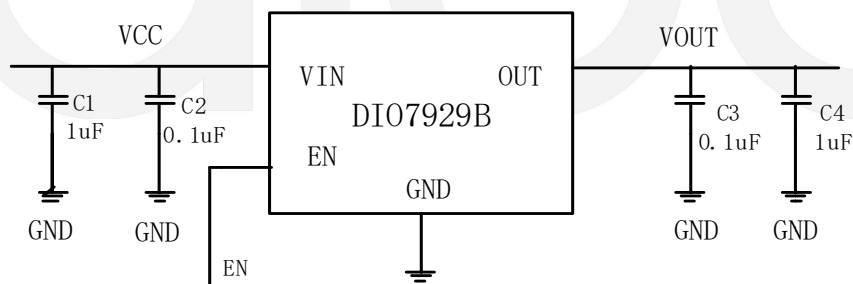



DIO7929B

5.5V rated 2A capable slew rate controlled load switch

Ordering Information

Order Part Number	Top Marking		T _A	Package	
DIO7929BST6	W79B	Green	-40 to +85°C	SOT23-6	Tape & Reel, 3000

Marking Definition

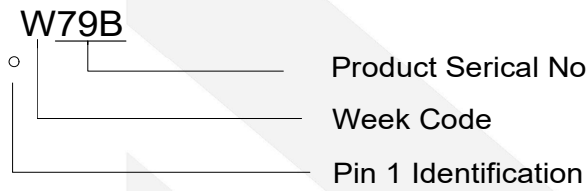

Pin Assignments

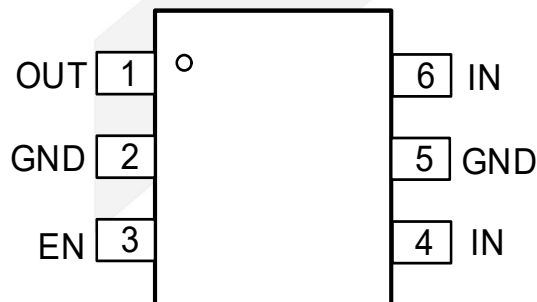

Pin Description

Pin	Name	Type	Description
1	OUT	Output	Switch Output; connect a 1μF capacitor from OUT to GND as close as possible to the IC.
2,5	GND	Power	GND
3	EN	Input	Enable input, logic high active.
4,6	IN	Power	Switch Input voltage; connect a 1μF or greater ceramic capacitor from IN to GND as close as possible to the IC.



DIO7929B

5.5V rated 2A capable slew rate controlled load switch

Absolute Maximum Ratings

Stresses beyond those listed under "Absolute Maximum Rating" may cause permanent damage to the device. These are stress ratings only and functional operation of the device at these or any other condition beyond those indicated in the operational sections of the specifications is not implied. Exposure to absolute maximum rating conditions for extended periods may affect device reliability.

Parameter		Rating	Unit
V _{IN}		-0.3 to 6	V
V _{OUT,EN}		-0.3 to 6	V
Storage Temperature		-65 to 150	°C
Maximum Junction Range		-40 to 145	°C
Thermal Resistance, θ_{JA}		190	°C/W
Power Dissipation, (T _A =25°C)		526	mW
Latch Up Protection		200	mA
ESD	HBM, JEDEC: JESD22-A114	6	kV
	CDM, JEDEC : JESD22-C101	2	

Recommended Operating Conditions

The Recommended Operating Conditions table defines the conditions for actual device operation to ensure optimal performance to the datasheet specifications. DIOO does not recommend exceeding them or designing to Absolute Maximum Ratings.

Symbol	Parameter	Conditions	Min.	Typ.	Max.	Unit
V _{IN}	Operational Power Supply		1.8		5.5	V
V _{EN}	Enable Voltage		0		5.5	V
C _{IN}	Decoupling input capacitor		1			μF
C _{OUT}	Decoupling output capacitor	USB port per Hub	1			μF
I _{OUT}	Maximum DC Current	T _A =25°C			2	A
I _{PEAK}	Maximum Peak Current	1ms pulse width at 217Hz , T _A =25°C			5	A
T _A	Ambient Temperature Range		-40	25	85	°C
T _J	Junction Temperature Range		-40	25	125	°C



DIO7929B

5.5V rated 2A capable slew rate controlled load switch

Electrical Characteristics

$T_A=25^{\circ}\text{C}$ $V_{IN} = 5\text{V}$, unless otherwise noted.

Symbol	Parameter	Conditions	Min.	Typ.	Max.	Unit
POWER SWITCH						
$R_{DS(ON)}$	Static drain-source on-state resistance	$V_{IN}=5\text{V}$, $T_A = 25^{\circ}\text{C}$		45		m Ω
		$I_{OUT}=200\text{mA}$, $-40^{\circ}\text{C} < T_A < 85^{\circ}\text{C}$			65	m Ω
t_R	Switch turn-on edge rising time	$V_{IN}=4.5\text{V}$ $C_{LOAD}=100\mu\text{F}$, $R_{LOAD}=150\Omega$	2	2.5	5	ms
t_F	Switch turn-off edge falling time	$V_{IN}=4.5\text{V}$ $C_{LOAD}=100\mu\text{F}$, $R_{LOAD}=150\Omega$		13		ms
t_{DON}	Switch turn-on delay	$V_{IN}=4.5\text{V}$; $C_{LOAD}=100\mu\text{F}$		1.5		ms
t_{DOFF}	switch turn-off delay	$V_{IN}=4.5\text{V}$; $C_{LOAD}=100\mu\text{F}$		10		μs
ENABLE INPUT EN						
V_{IH}	High-level input voltage		1.45			V
V_{IL}	Low-level input voltage				0.85	V
R_{PD}	Pull-down resistance at EN pin	$T_A = -45^{\circ}\text{C}$ to $+85^{\circ}\text{C}$		1		M Ω
REVERSE-LEAKAGE PROTECTION						
I_{REV}	Reverse-current protection	$V_{IN}=0\text{V}$, $V_{OUT}=4.2\text{V}$, $-40^{\circ}\text{C} < T_A < 85^{\circ}\text{C}$, $EN="0"$		1	2	μA
QUIESCENT CURRENT						
I_Q	Current consumption	$V_{IN}=5\text{V}$, V_{OUT} floating, $EN = 5\text{V}$		100	140	μA
I_{SDN}	shutdown current	$V_{IN}=5\text{V}$, $EN="0"$, $V_{OUT}=\text{GND}$, $-40^{\circ}\text{C} < T_A < 85^{\circ}\text{C}$			1	μA

Note: This parameter is guaranteed by design and characterization.



DIO7929B

5.5V rated 2A capable slew rate controlled load switch

Application information

Enable

Enable pin voltage in the active high means on. This part is automatically turned on when the input voltage enables the device. In the other side, this part is turned off when the input voltage is not available, which limits current consumption from battery to V_{OUT} pin.

Input Capacitor

To limit the voltage drop on the input supply caused by transient inrush currents, an input capacitor is placed to the V_{IN} and GND as close as possible. The value of the input capacitor is recommended $1\mu\text{F}$ at least. Higher values capacitor can help to further reduce the voltage drop.

Output Capacitor

While the device works, a capacitor from 100nF to $1\mu\text{F}$ across V_{OUT} and GND is recommended to accommodate load transient condition. It also helps to prevent parasitic inductance forces V_{OUT} below GND when switching off. Output capacitor has the minimal effect on device's turn on slew rate time.

Blocking Control

The blocking control circuitry switches the bulk of the power NMOS. When the part is off (No V_{IN} or EN tied to GND externally), the body diode limits the leakage current I_{REV} from OUT to IN. In this condition, the anode of the body diode is connected to IN pin and the cathode is connected to OUT pin. During the operation, the anode of the body diode is connected to OUT pin and the cathode is connected to IN pin to prevent the discharge of the power supply.





DIO7929B

5.5V rated 2A capable slew rate controlled load switch

Typical Performance Characteristics

$T_A=25^{\circ}\text{C}$ $V_{IN}=5\text{V}$, unless otherwise noted.

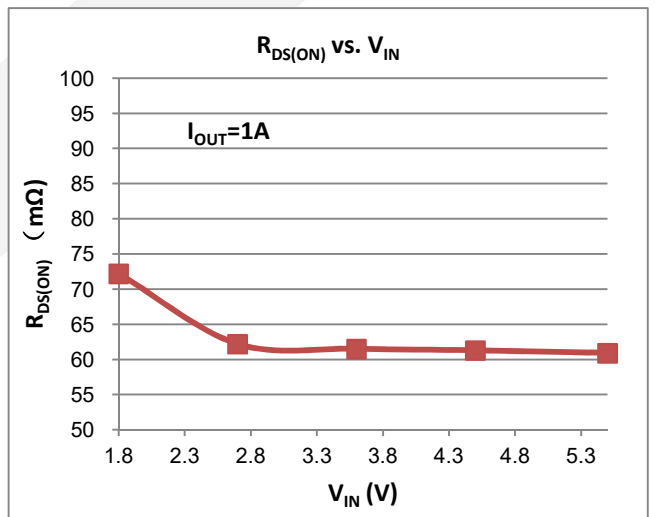
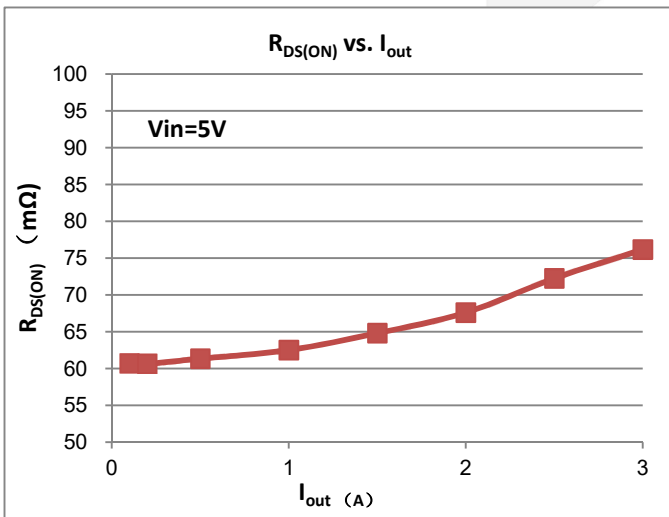
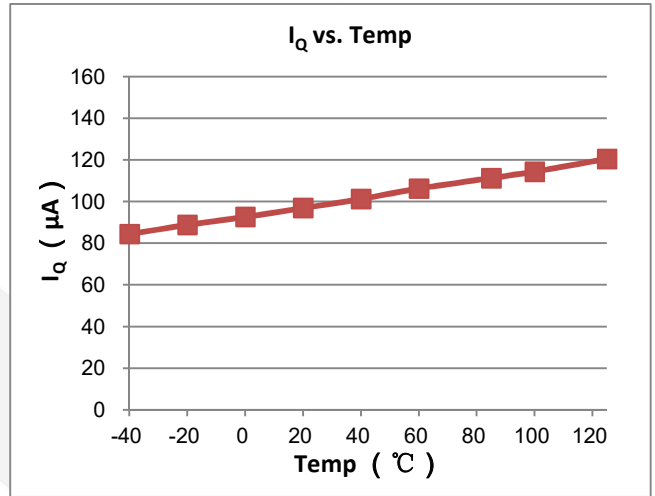
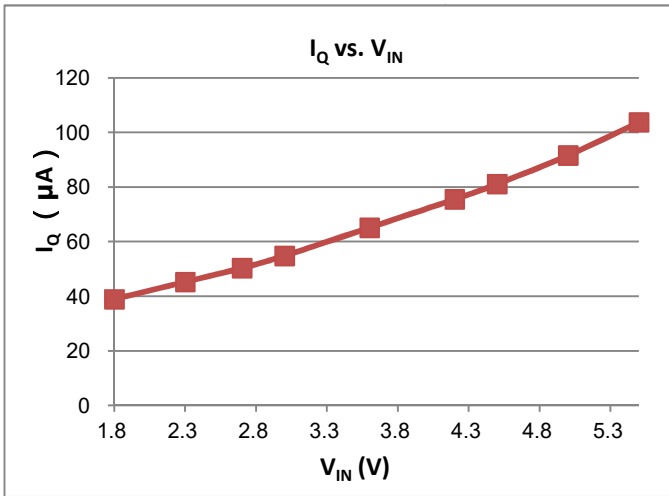

$V_{IN}=5\text{V}$, $R_{OUT}=5\Omega$, $C_{OUT}=100\mu\text{F}$, Turn on delay time

$V_{IN}=5\text{V}$, $R_{OUT}=5\Omega$, $C_{OUT}=100\mu\text{F}$, Turn off delay time

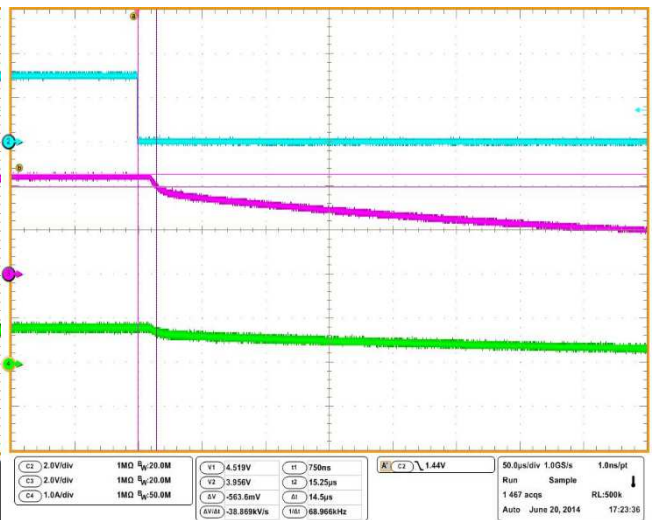
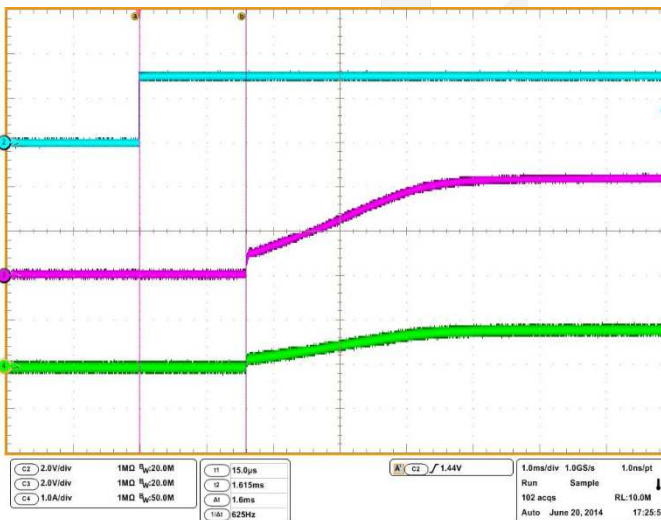

$V_{IN}=5V, R_{OUT}=5.1\Omega, V_{IN}$ Startup

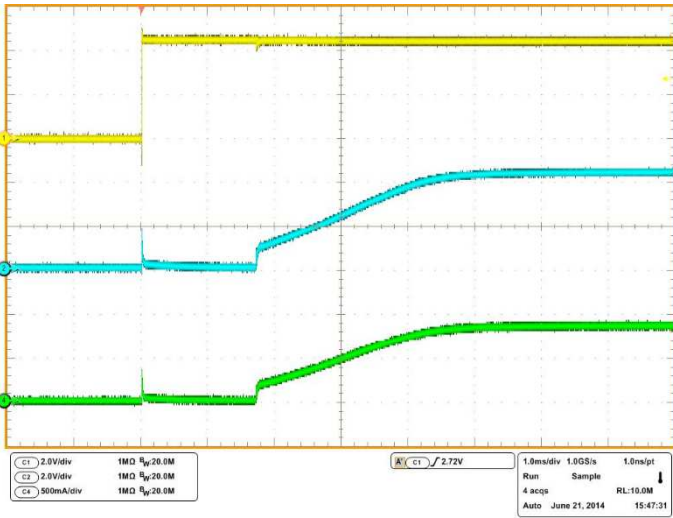

$V_{IN}=5V, R_{OUT}=5.1\Omega, V_{IN}$ Shutdown

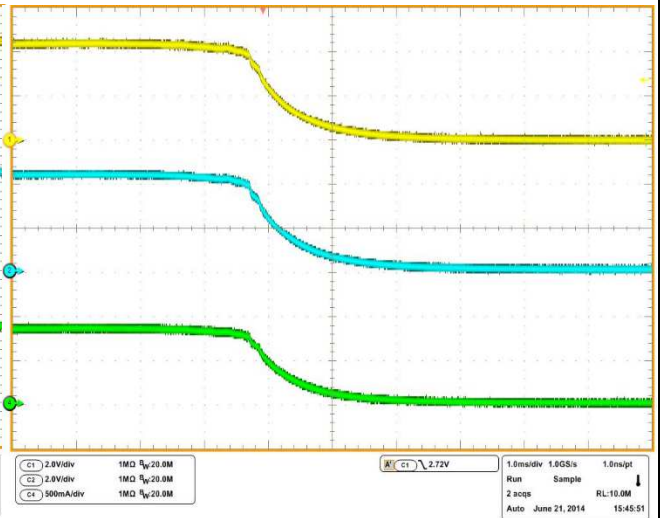

$V_{IN}=5V, R_{OUT}=5.1\Omega, EN$ Startup

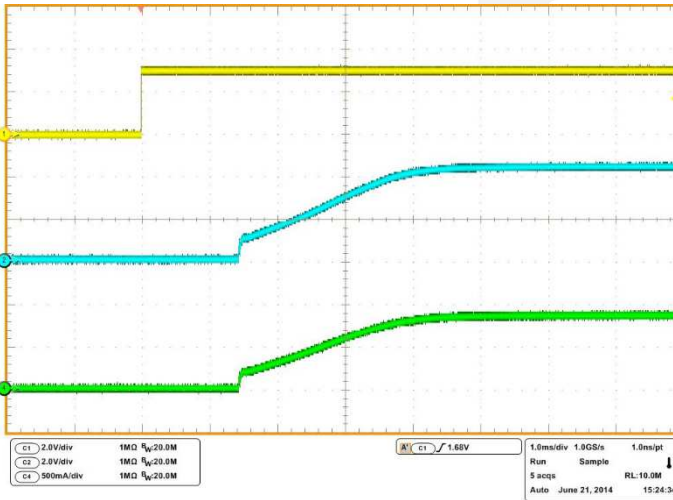

$V_{IN}=5V, R_{OUT}=5.1\Omega, EN$ Shutdown

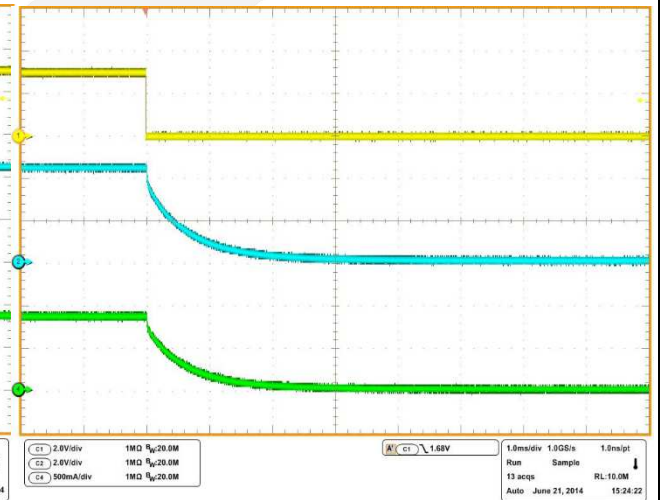



DIO7929B

5.5V rated 2A capable slew rate controlled load switch

CONTACT US

Dioo is a professional design and sales corporation for high-quality and performance analog semiconductors. The company focuses on industry markets, such as, cell phone, handheld products, laptop, and medical equipment and so on. Dioo's product families include analog signal processing and amplifying, LED drivers and charger IC. Go to <http://www.dioo.com> for a complete list of Dioo product families.

For additional product information, or full datasheet, please contact with our Sales Department or Representatives.

